

FLP7-320/2
FLP7-320/2S

Modular surge arrester for use in single-phase TN systems; with floating remote signalling contact.

- Prewired complete unit consisting of a base part and plug-in protection modules
- High discharge capacity due to heavy duty zinc oxide varistor
- High reliability due to "Thermo Dynamic Control" SPD monitoring device

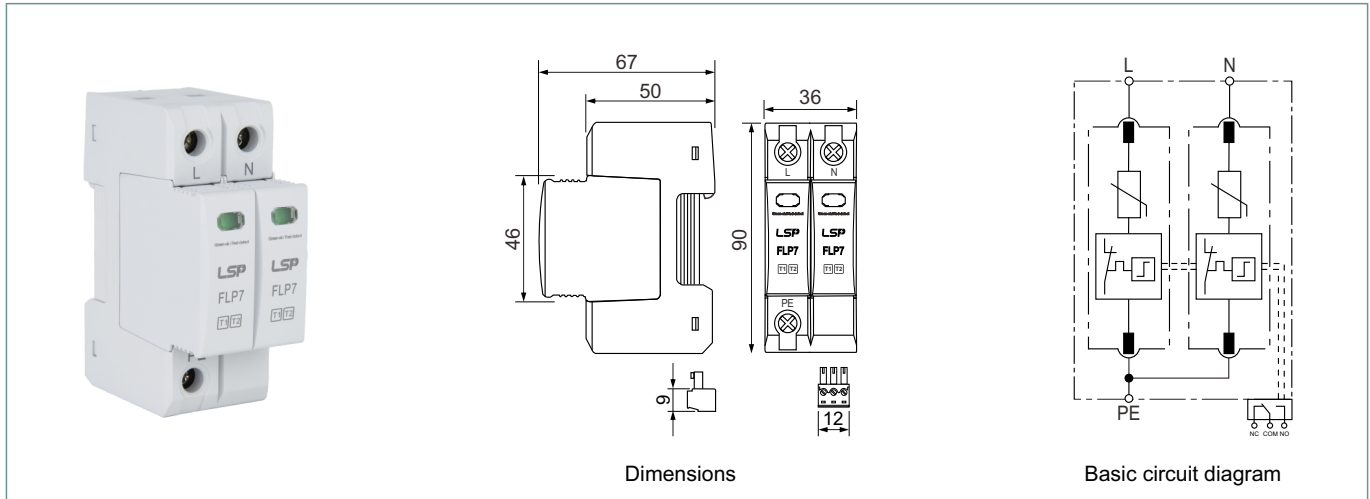

Type		FLP7-320/2	FLP7-320/2S
SPD according to EN61643-11/IEC61643-11		type 1 + type 2 / class I + class II	type 1 + type 2 / class I + class II
Nominal a.c. voltage	U_n	230 / 400 V AC (50/60 Hz)	230 / 400 V AC (50/60 Hz)
Max. continuous operating a.c. voltage	U_c	320 V AC (50/60 Hz)	320 V AC (50/60 Hz)
Nominal discharge current (8/20 μ s)	I_n	20 kA	20 kA
Maximum discharge current (8/20 μ s)	I_{max}	50 kA	50 kA
Lightning impulse current (10/350 μ s)	I_{imp}	7 kA	7 kA
Voltage protection level	U_P	2,0 kV	2,0 kV
Response time	t_a	25 ns	25 ns
Max. mains-side over-current protection		160 AgL/gG	160 AgL/gG
Short-circuit current rating	I_{scCR}	25 kA _{rms}	25 kA _{rms}
Temporary overvoltage (TOV) (U_T) - Characteristic		335 V / 5 sec. - withstand	335 V / 5 sec. - withstand
Temporary overvoltage (TOV) (U_T) - Characteristic		440 V / 120 min. - safe failure	440 V / 120 min. - safe failure
Range of operating temperatures	T_U	-40/+80°C	-40/+80°C
Operating state / fault indication		green / red	green / red
Number of ports		1	1
Cross-sectional area (min.)		1.5 mm ² solid /flexible	1.5 mm ² solid /flexible
Cross-sectional area (max.)		35 mm ² stranded / 25 mm ² flexible	35 mm ² stranded / 25 mm ² flexible
For mounting on		35 mm DIN rail acc. to EN 60715	35 mm DIN rail acc. to EN 60715
Enclosure material		thermoplastic	thermoplastic
Place of installation		indoor installation	indoor installation
Degree of protection		IP 20	IP 20
Capacity		2 module(s), DIN 43880	2 module(s), DIN 43880
Approvals		CE	CE
Type of remote signalling contact		-	changeover contact
a.c. switching capacity		-	250V / 0.5A
d.c. switching capacity		-	250V / 0.1A; 125V / 0.2A; 75V / 0.5A
Cross-sectional area for remote signalling terminals		-	max. 1.5 mm ² solid / flexible