

# CE INSTALLATION INSTRUCTIONS



## LSP PV SPD FLP-PV Series

- DE Einbauanleitung
- GB Installation instructions
- IT Istruzioni di montaggio
- FR Instructions de montage
- NL Montagehandleiding
- ES Instrucciones de montaje
- PT Instruções de montagem
- DK Monteringsvejledning
- SE Monteringsanvisning
- FI Asennusohje
- GR Οδηγίες συναρμολόγησης
- PL Instrukcja montażu
- CZ Návod k montáži
- TR Montaj kılavuzu
- RU Инструкция по монтажу
- CN 安装说明
- HU Szerelési útmutató
- JP 設置説明書



I+II IEC 61643-31...  
1+2 EN 50539-11...

Pozidriv® Z2 4 Nm

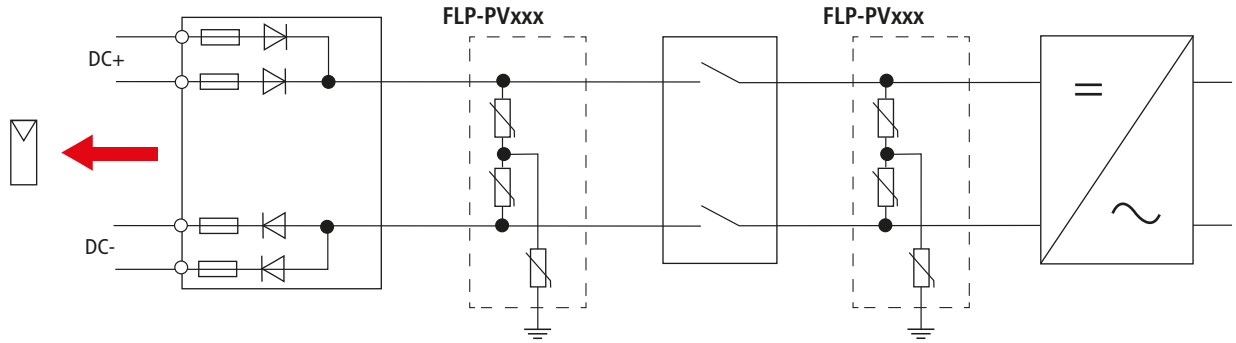
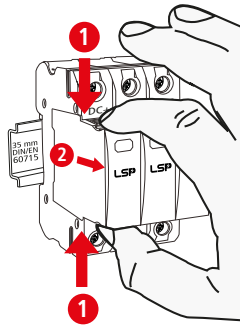
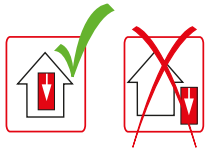
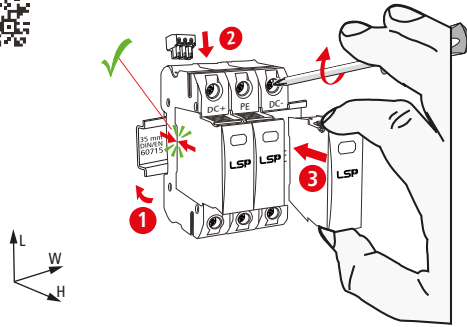

FLP-PV600

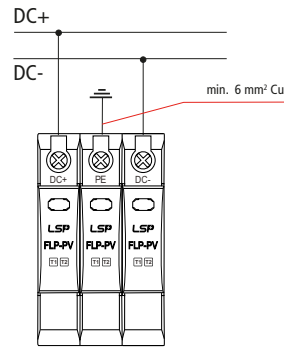

FLP-PV1000

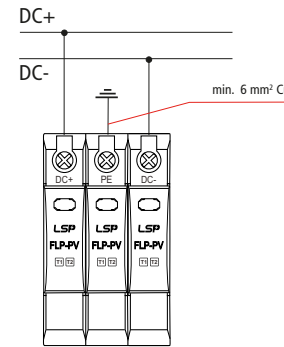

FLP-PV1200

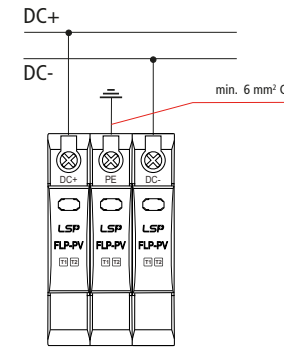

FLP-PV1500

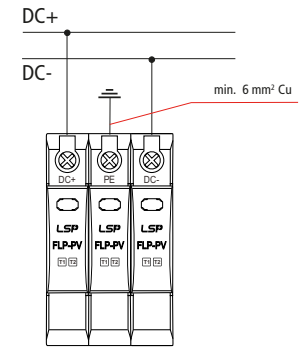

	FLP-PV600	FLP-PV1000	FLP-PV1200	FLP-PV1500
$U_{CPV}$	≤ 600 V DC	≤ 1000 V DC	≤ 1200 V DC	≤ 1500 V DC
$I_n$		20 kA (8/20)		
$I_{max}$		40 kA (8/20)		
$I_{imp}$		6,25 kA (10/350)		
$I_{total}$		12,5 kA (10/350)		
$I_{scpv}$		2000 A		
$I_{PE,AC}$		≤ 500 $\mu$ A		
$I_{PE,DC}$		≤ 25 $\mu$ A		
$\theta$		-40°C ... +70°C		
$\varphi$		5% ... 95%		
IP *)		20		
failure behavior		open circuit		
L x W x H	90 mm x 36 mm x 81 mm	90 mm x 54 mm x 81 mm		

	min. $\square$ DC+ / -, DC- / +, $\downarrow$	max. $\square$ DC+ / -, DC- / +, $\downarrow$
	12 mm	12 mm
	12 mm	12 mm
	12 mm	12 mm
	1.5 mm <sup>2</sup>	35 mm
	16 mm <sup>2</sup> Cu	≤ 15.5 mm

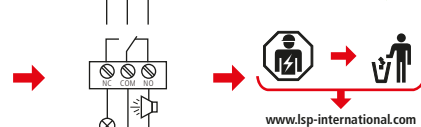
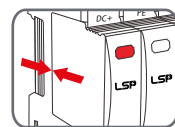
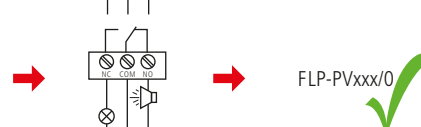
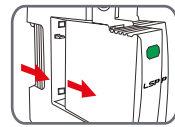
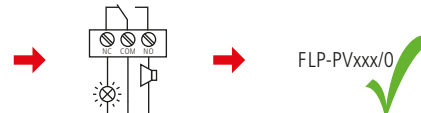
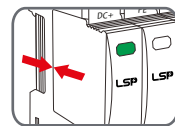

RED=REPLACE

www.lsp-international.com

LSP PV SPD FLP-PV Series Remote Signalling Contact	
	$U_N / I_N$ AC: 250 V / 0.5 A
	DC: 250 V / 0.1 A 125 V / 0.2 A 75 V / 0.5 A
	max. 1.5 mm <sup>2</sup>

