

CE INSTALLATION INSTRUCTIONS

LSP PV SPD SLP-PV Series

DE Einbauanleitung
 GB Installation instructions
 IT Istruzioni di montaggio
 FR Instructions de montage
 NL Montagehandleiding
 ES Instrucciones de montaje
 PT Instruções de montagem
 DK Monteringsvejledning
 SE Monteringsanvisning
 FI Asennusohje
 GR Οδηγίες συναρμολόγησης
 PL Instrukcja montażu
 CZ Návod k montáži
 TR Montaj kılavuzu
 RU Инструкция по монтажу
 CN 安装说明
 HU Szerelési útmutató
 JP 設置説明書



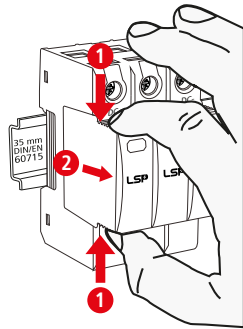
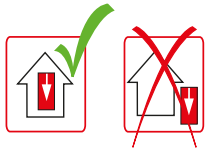
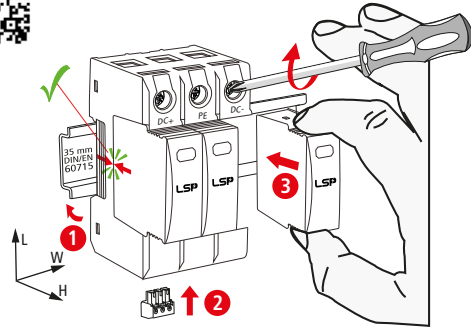

IEC 61643-31...
 2 EN 50539-11...

Pozidriv® Z2 4 Nm

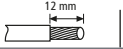
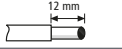
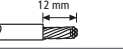

	SLP-PV600	SLP-PV1000	SLP-PV1200	SLP-PV1500
U_{CPV}	≤ 600 V DC	≤ 1000 V DC	≤ 1200 V DC	≤ 1500 V DC
I_n		20 kA (8/20)		
I_{max}		40 kA (8/20)		
I_{SCP}		2000 A		
$I_{PE,AC}$		≤ 500 μ A		
$I_{PE,DC}$		≤ 25 μ A		
θ		-40°C ... +70°C		
φ		5% ... 95%		
IP *)		20		
failure behavior		open circuit		
L x W x H	90 mm x 36 mm x 67 mm	90 mm x 54 mm x 67 mm		

min. □ DC+ / -, DC- / +, ↓			
max. □ DC+ / -, DC- / +, ↓		1.5 mm ²	35 mm
□ 	16 mm ² Cu		≤ 15.5 mm

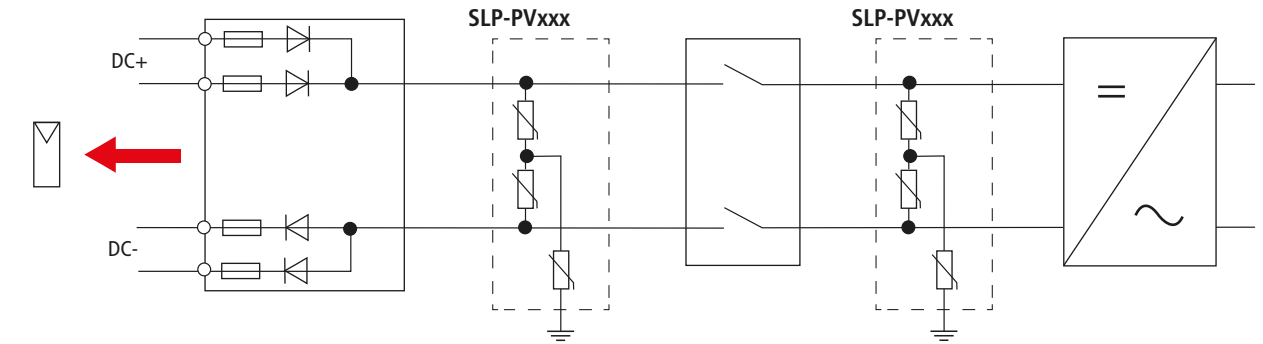

SLP-PV600

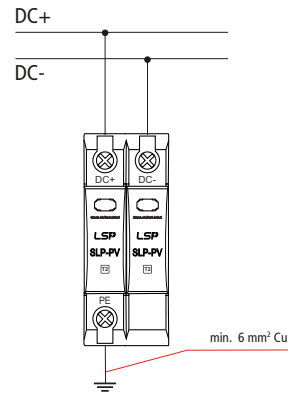

SLP-PV1000

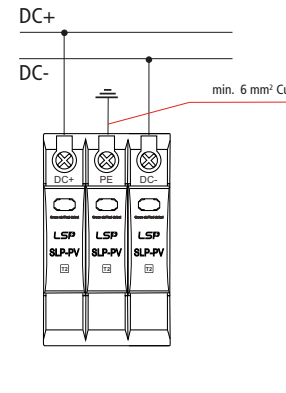

SLP-PV1200

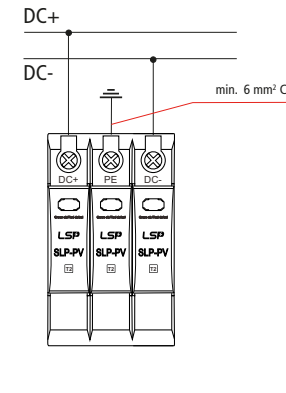

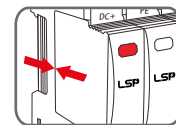
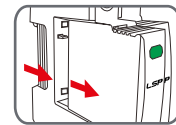
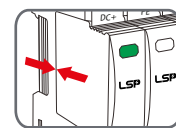
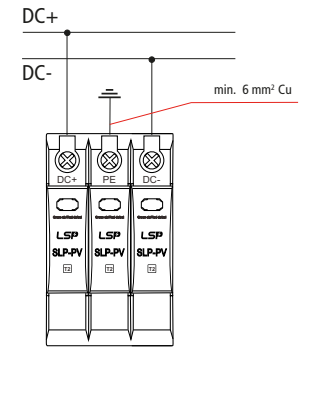

SLP-PV1500

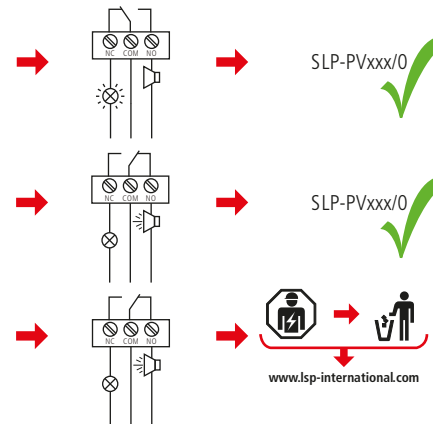

RED=REPLACE



LSP PV SPD SLP-PV Series Remote Signalling Contact	
	U_N / I_N AC: 250 V / 0.5 A
	DC: 250 V / 0.1 A 125 V / 0.2 A 75 V / 0.5 A
	max. 1.5 mm ²

